

[www.mundilite.com](http://www.mundilite.com)

Apdo. de Correos 72

C/ Malvasia Parc. 9 y 11 - Polígono Industrial Pino Blay - 46380 Cheste - Valencia - Spain

Telfs +34 96 251 28 94 / +34 96 070 23 81 - Fax: +34 96 251 14 78

email: [admon@mundilite.com](mailto:admon@mundilite.com)

  
mundilite



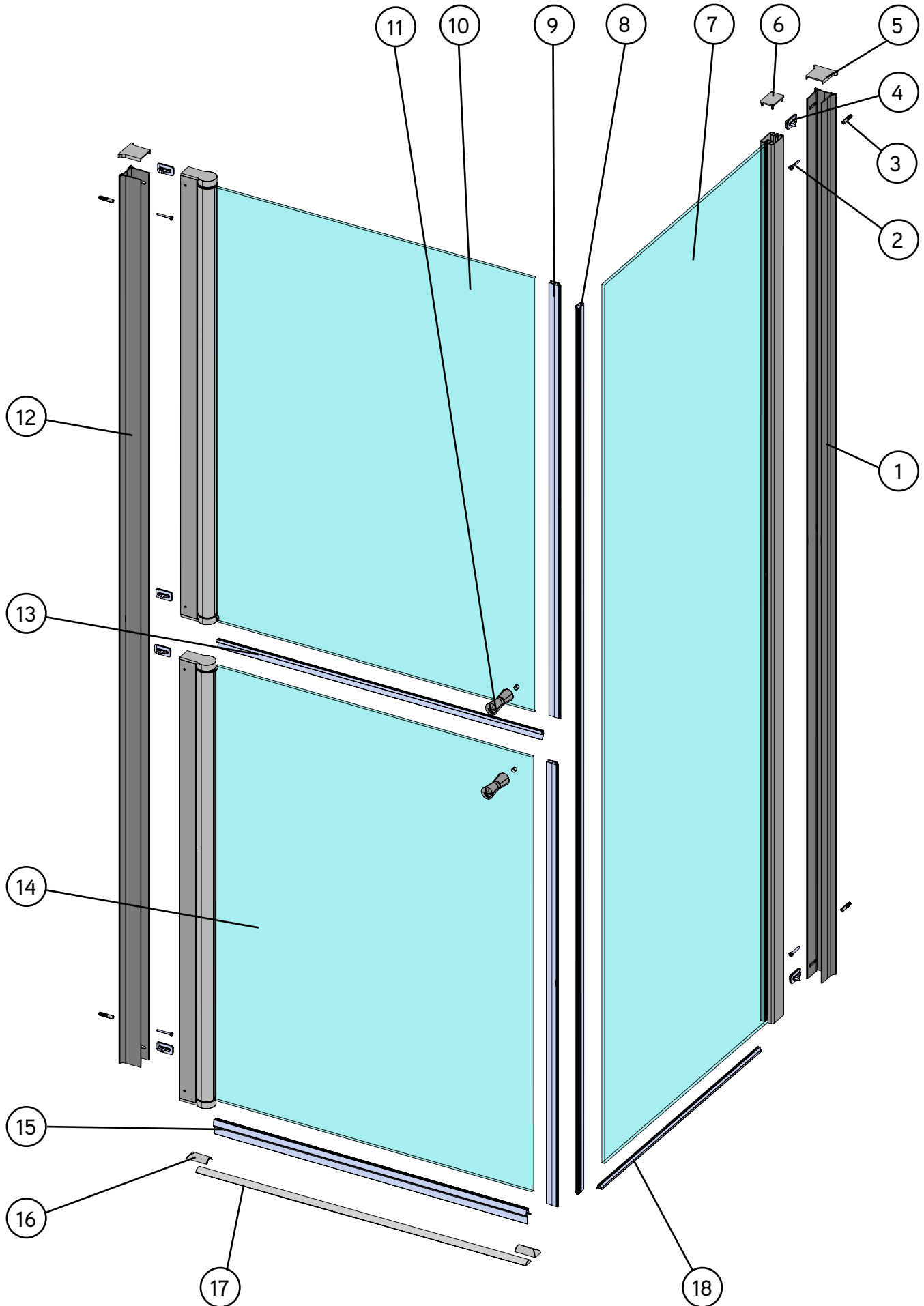

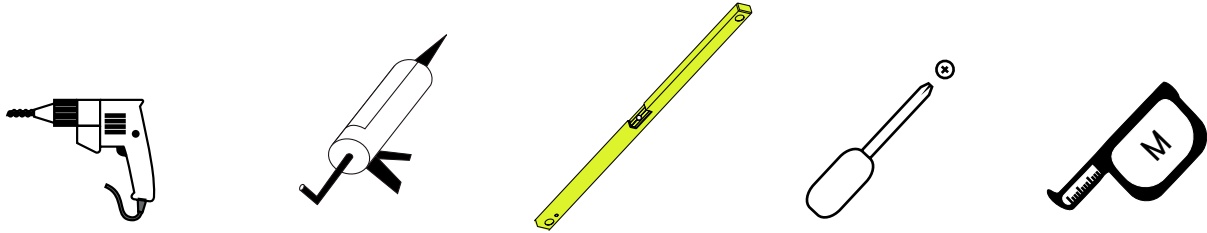

# D-40

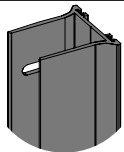
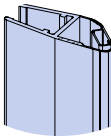
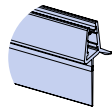
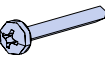
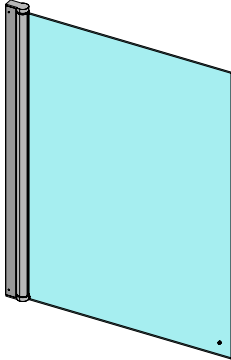

Herramientas / Tools / Outils / Strumenti di costruzione

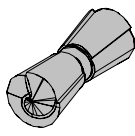

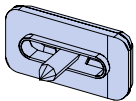
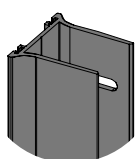
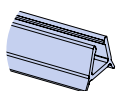
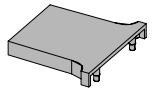
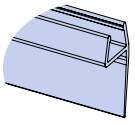
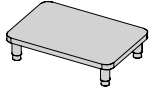
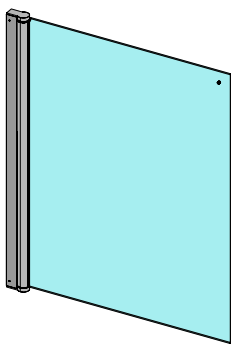
Equipamiento / Features / Équipement / Capitolato

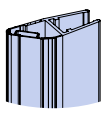
Ref.		Quant.	Ref.		Quant.	Ref.		Quant.
1.		1 Pc.	9.		2 Pc.	15.		1 Pc.
2.		4 Pc.	10.		1 Pc.	16.		2 Pc.
3.		4 Pc.	11.		2 Pc.	17.		1 Pc.
4.		6 Pc.	12.		1 Pc.	18.		1 Pc.
5.		2 Pc.	13.		1 Pc.			
6.		1 Pc.	14.		1 Pc.			
7.		1 Pc.						
8.		1 Pc.						

# D-40

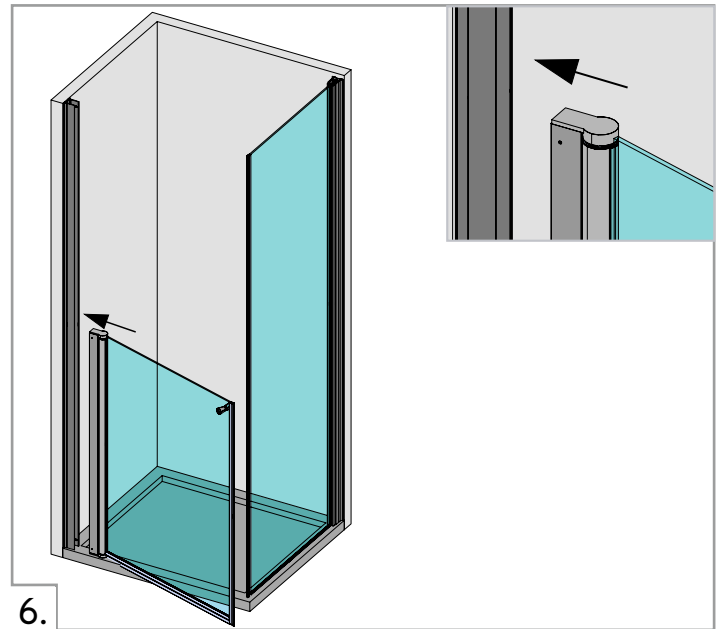
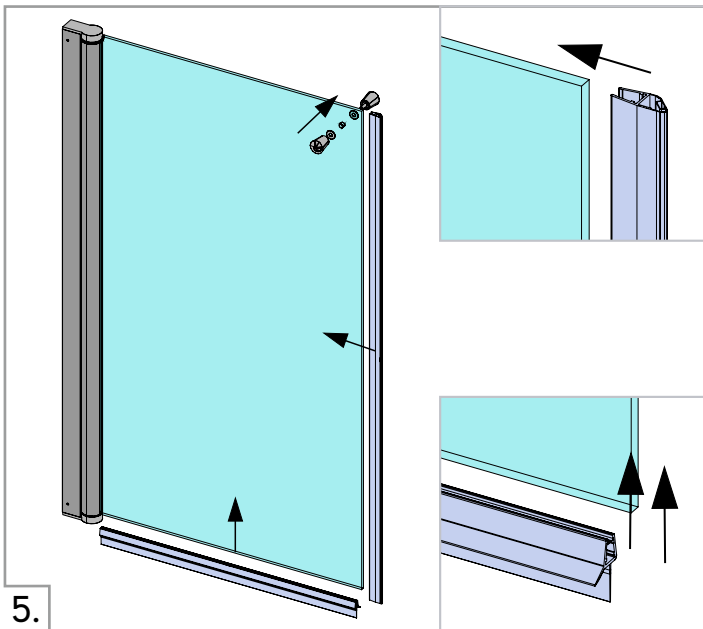
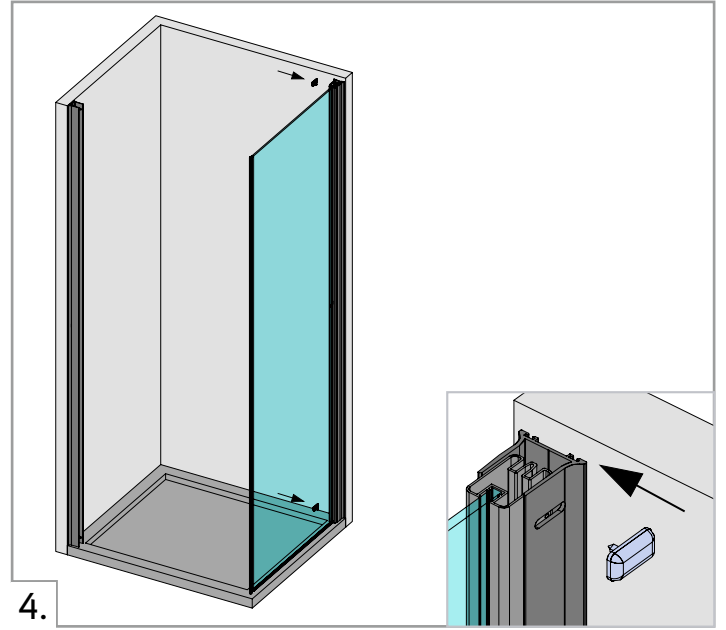
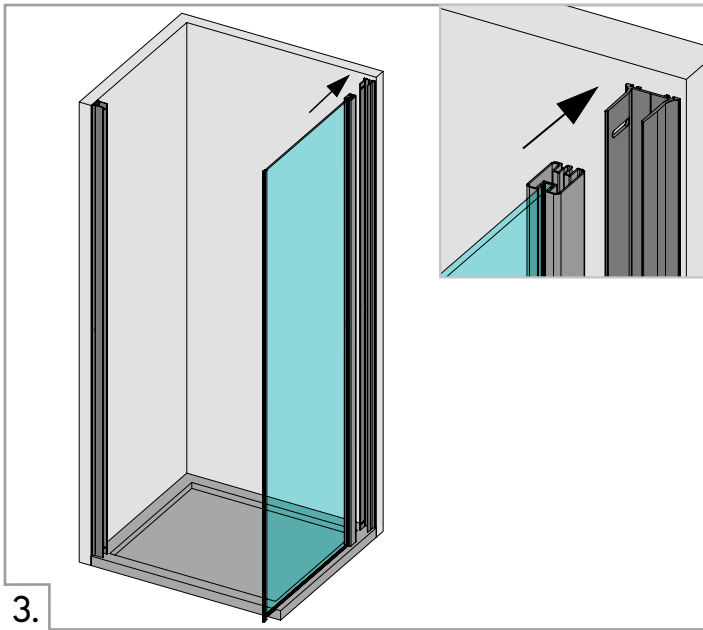
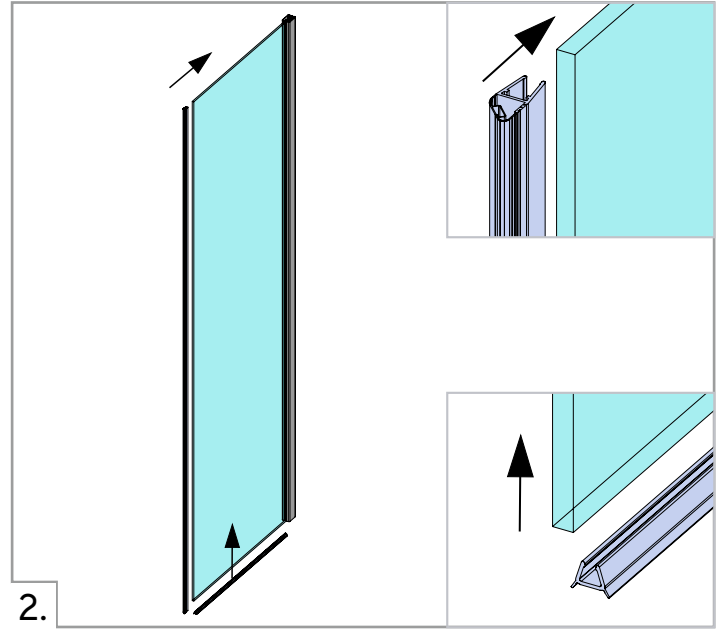
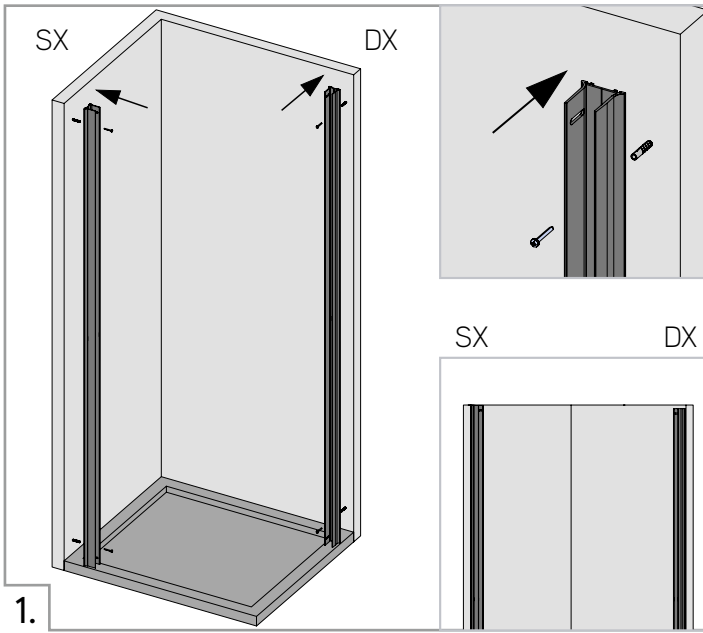

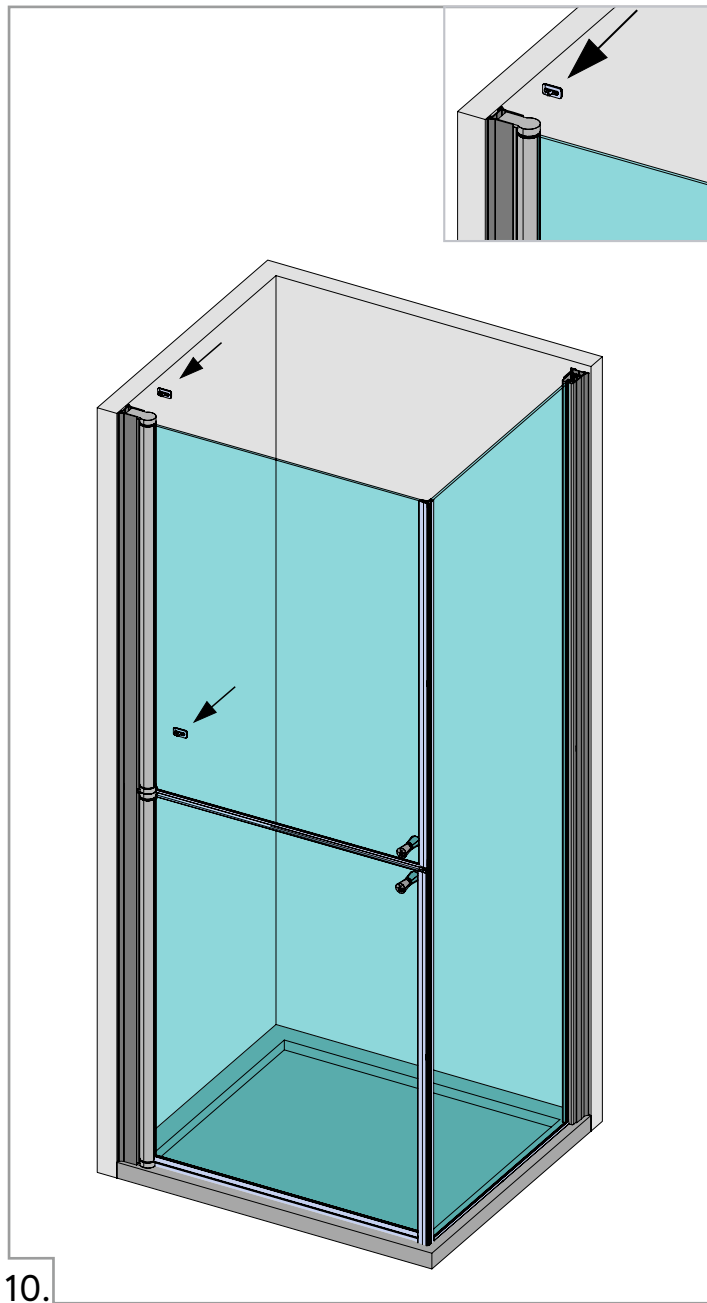
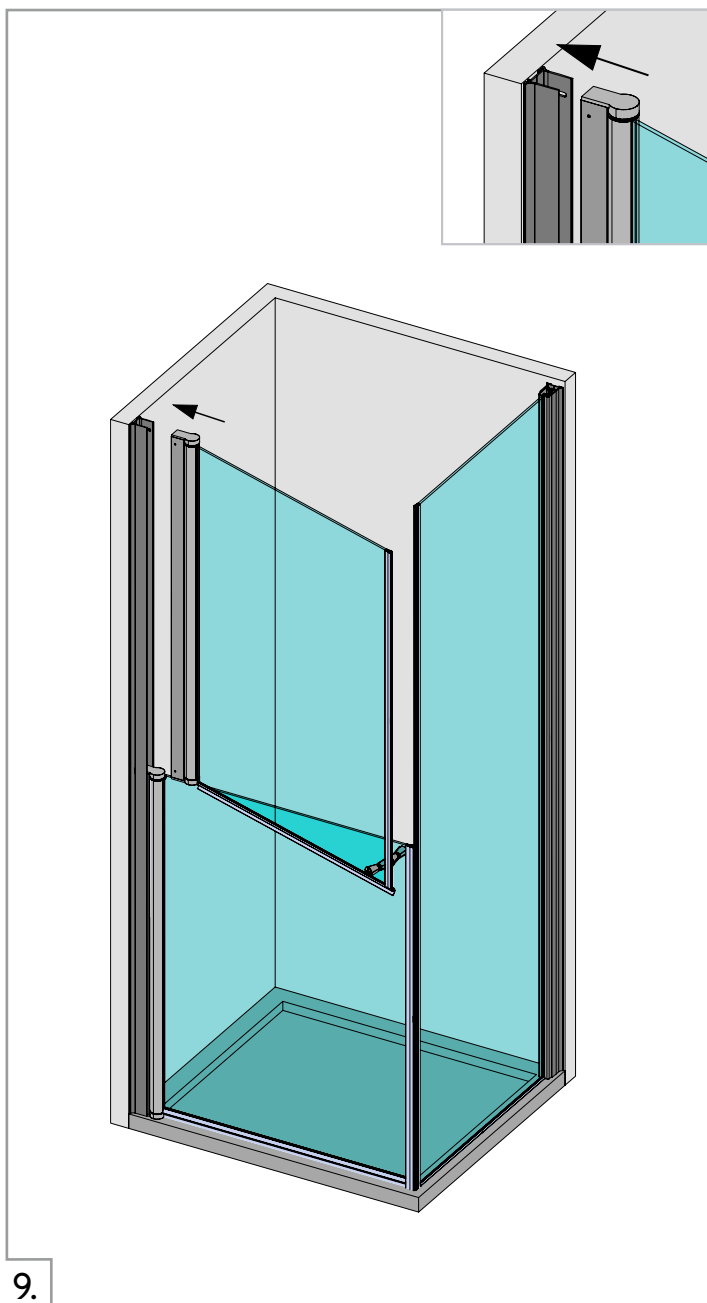
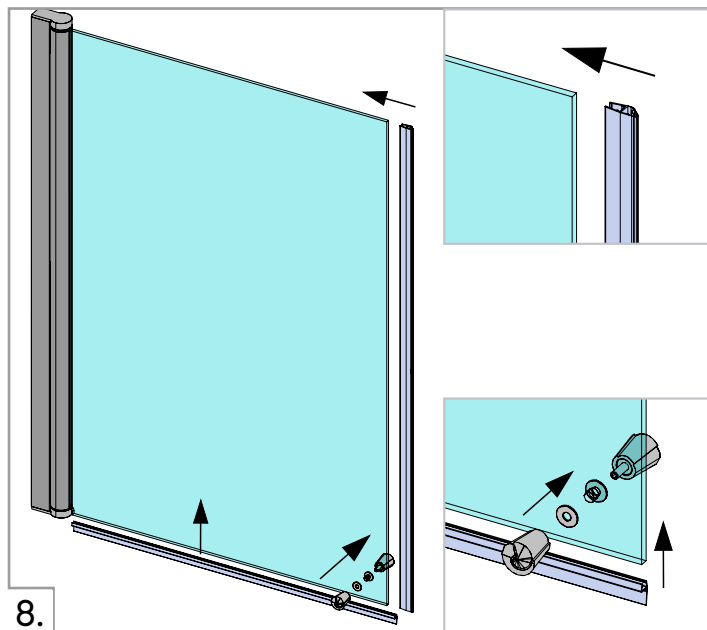
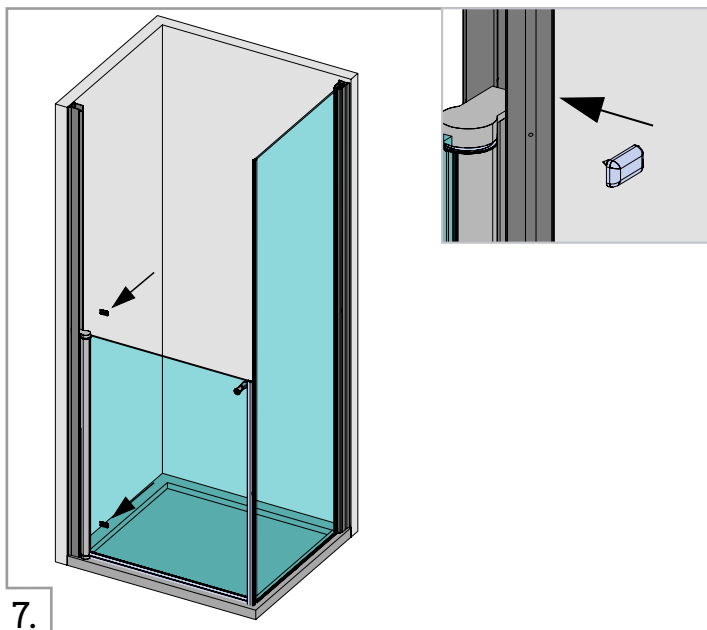

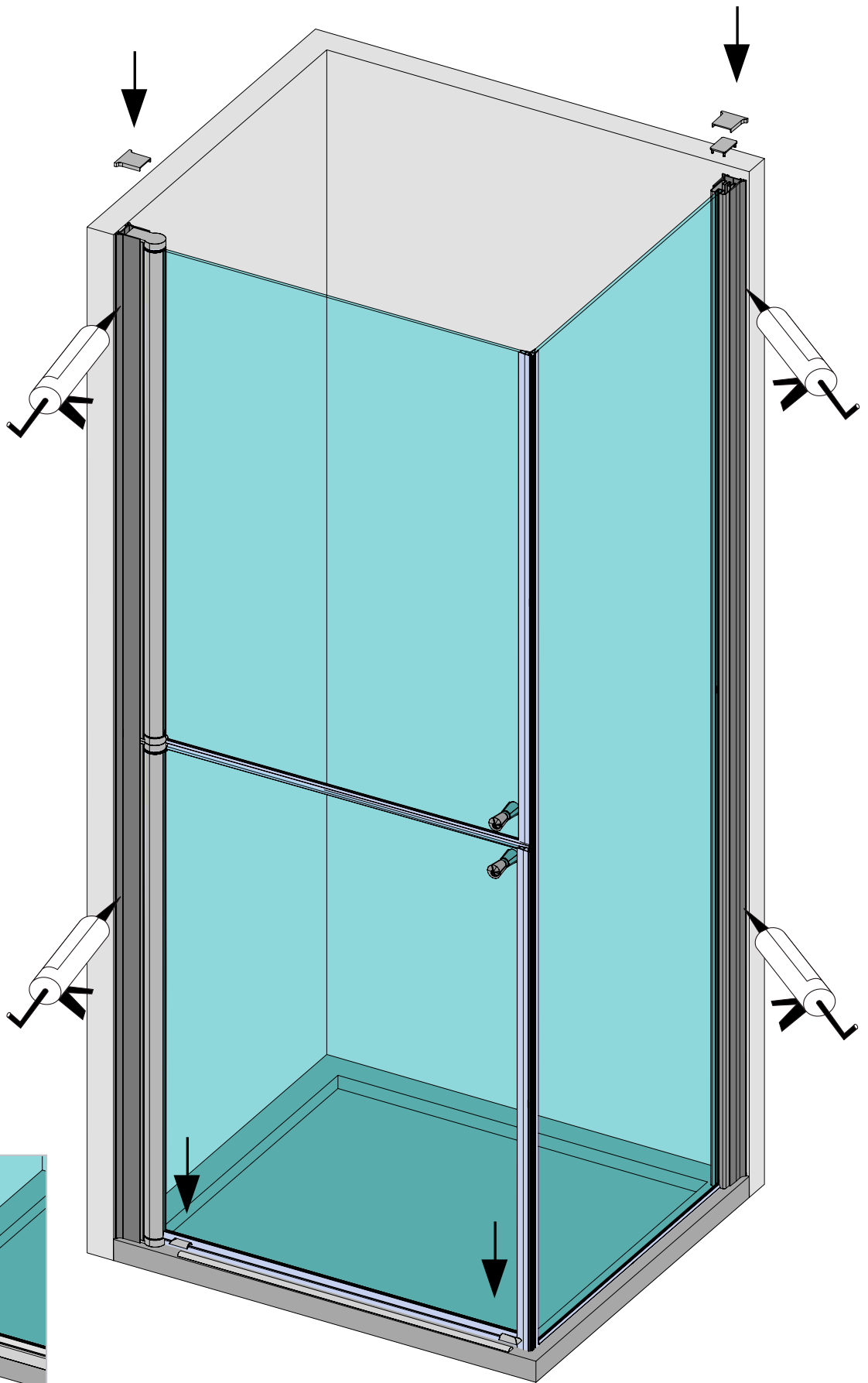

11.